

Two Conventional Methods:

Like most things in quilting, there is more than one way to square up the edge and there are advantages and disadvantages to each method.

Conventional Method 1: Use Just One Ruler.



Trim the right edge off.

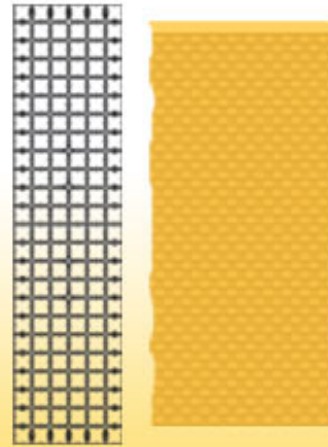
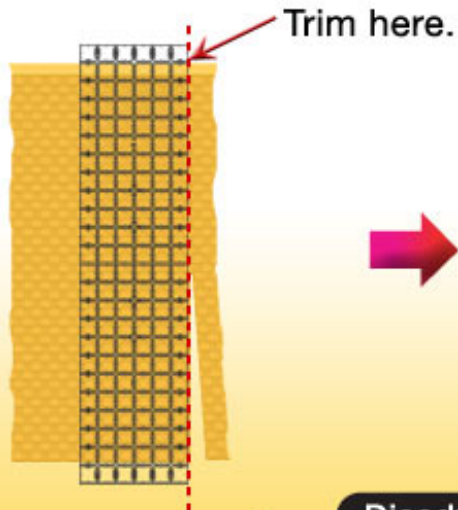

Advantage:

It's easy to control one ruler to accurately align to the fabric.

Disadvantage:

You have to rotate the fabric 180° to start cutting strips because the newly cut edge is on the opposite side.

Conventional Method 2: Use Two Rulers.

Remove the second ruler and trim the left edge off.

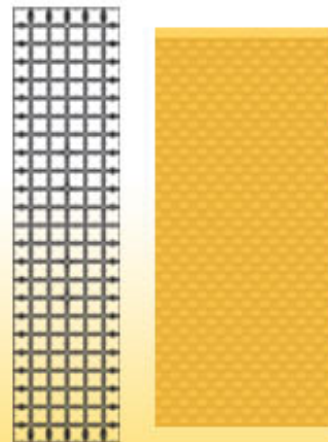
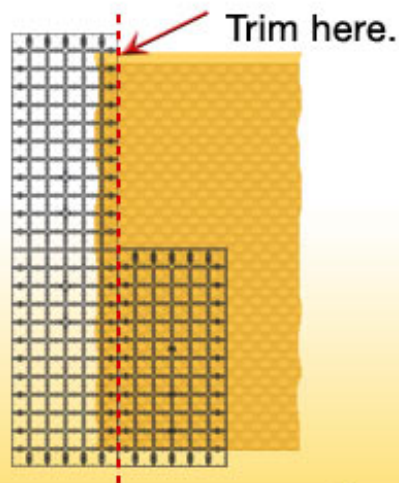

Disadvantage:

It's unwieldy to keep two rulers aligned with each other while lining them up to the fabric's edge.

Advantage:

You can start cutting strips from the same side.

(Sides are reversed for left handers.)

New, Easy Way, Using the Quilt Ruler Connector:



QUILT RULER CONNECTOR™

Connect Any Two Acrylic Rulers.



*Built-in handle
for easy pickup*

Made in USA

End-to-End

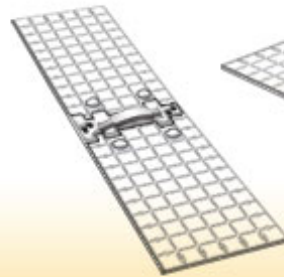

Side-by-Side



Corner Square

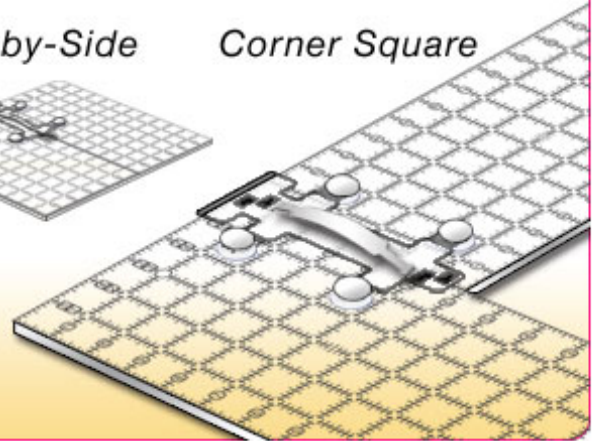

Connect your 12" ruler to your 24" ruler as a corner square.

Advantage 1: It's as easy as lining up using just one ruler.

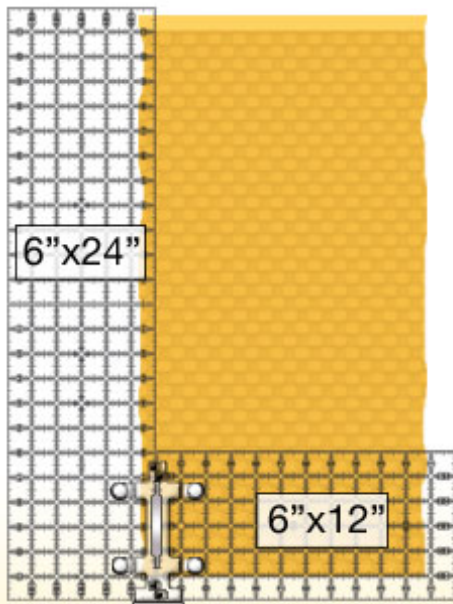

Advantage 2: You'll have a longer line to line up to the folded edge for greater accuracy.

Remove the 12" Ruler and Connector.

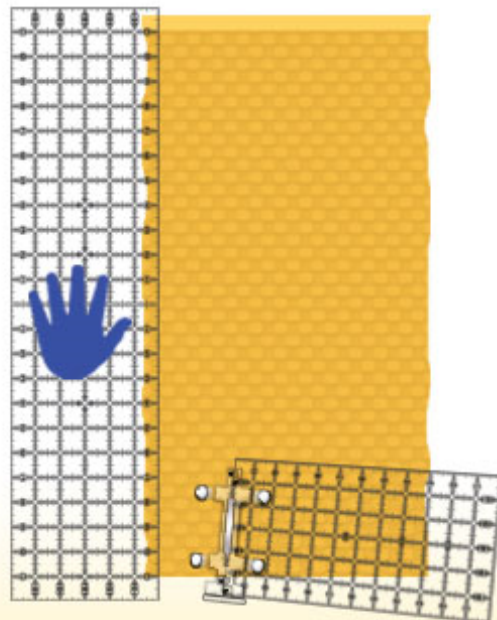

Advantage 3: You can start cutting strips from the same side of the fabric.

Other Ways to Use the Quilt Ruler Connector:

You can also make a 3-foot ruler to cut bias binding strips.

Connect your 12" and 24" Rulers to Make a 3-Foot Ruler and Cut Bias Binding Strips:

Sometimes a 3-Foot Ruler is Just What You Need,

But who wants to pay for another ruler, especially one that long? Besides, carrying or storing a 3-foot-ruler would be a major hassle.

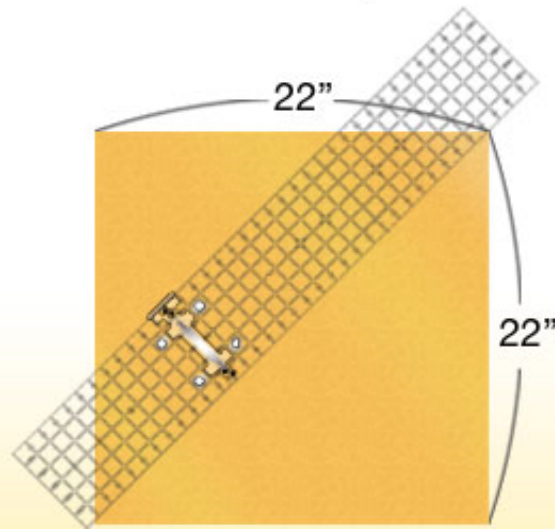

The **Quilt Ruler Connector** lets you connect two acrylic rulers **Fast and Accurately with No Sticky Residue.**

Easy to Carry. Easy to Store.

No need to take a 24" long ruler to class:

Two 12" rulers and a connector easily fit in a small bag or even in the case with your sewing machine and can be connected to make a 6"x24" or 12" square when needed.

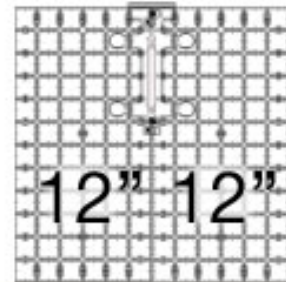
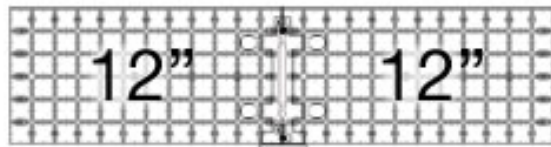

Other Combinations:

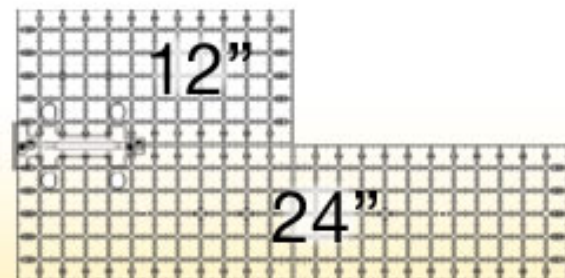
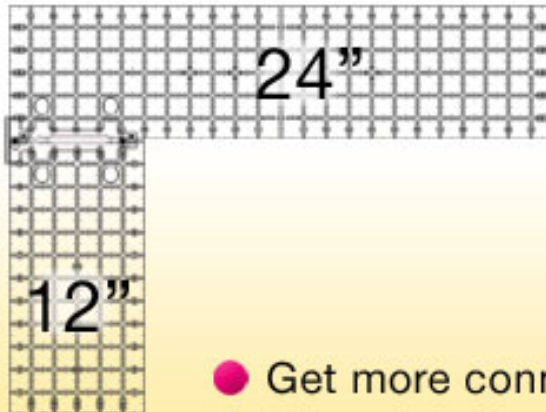
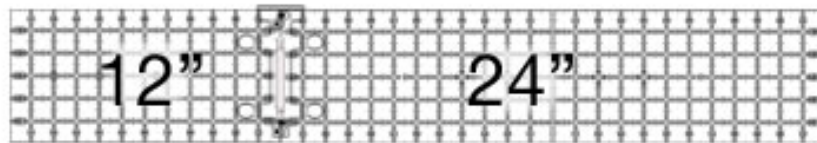

- Get more connectors to join multiple rulers.